

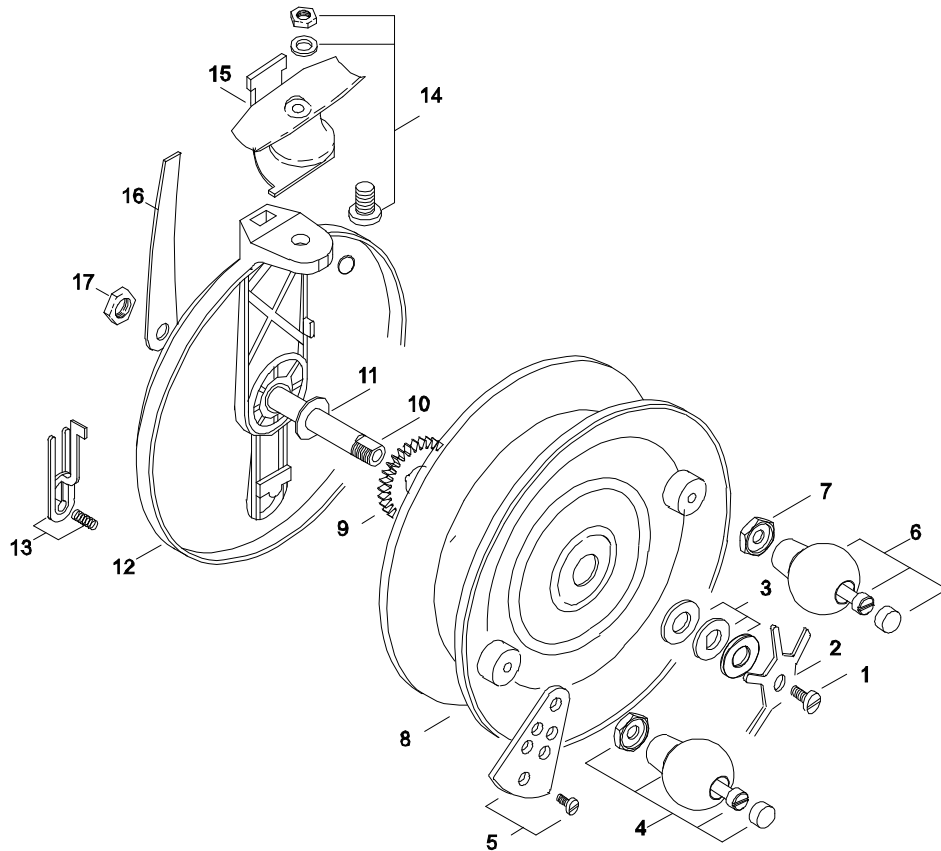

62GRT4



Key	Part	Description	Key	Part	Description
1	R6E1	Spindle Screw	10	R6A1	Spindle
2	R6B3	Spindle Nut	11	R6R2	Fibre Washer
3	R6L6	Washer Set	12	R1A	Reel without spool
4	R4F6	Handle Assembly	13	R5E10	Ratchet Button
5	R4M3A	Handle Plate & Screw	14	R2DEF4	Bolt, Nut, Washer (turbo)
6	R4F21	Handle Assembly	15	R2A7	Base Assembly
7	R4G2	Handle Lock Nut	16	R2G12	Base Lock Spring
8	R4B	Spool only	17	R6F3	Dome Hex Nut
9	R5B4	Ratchet Wheel			

CONGRATULATIONS and thank you for purchasing one of our Australian made competition series turbo cast reels as your choice of fishing reel. These reels are constructed from the highest quality materials to ensure your reel will last for many years.

Plus, all these other advantages -

Long, accurate casts:
Now, with only the minimum of practise you will be able to cast further and more accurately than ever before.

Control large fish with ease:
Powerful one-to-one wind means you only need about a quarter of the effort required to lift a similar weight on a spinning reel.

You can fish harder and longer: Simple, rugged construction means you can forget that fiddly maintenance, because your Alvey reel will resist the effects of saltwater and sand.

Special Features

- Rapid Retrieve Handle Plate
- Turbo
- Strong Graphite Back Plate
- Light Weight Spool
- Stainless Steel Bush
- Star Tensioner

More comfortable fishing:
Low winch-mount rods let you fish with your arms in a relaxed position.

No line twist: Use a small free-running swivel as the last piece in any rig and you'll minimise any line twist. (See illustrations inside)



Alvey 10 Year Guarantee:
Any faulty Alvey part or reel will be replaced at no charge providing the manufacturer finds the part or reel has had normal usage and attention.

Reel Icon Pty Ltd Trading as
Alvey Reels Australia ABN 57 625 261 707
2-6 Antimony Street Carole Park Qld 4300
t: +61 7 3271 2844 f: +61 7 3271 2451

For more hints and tips on maintenance, please visit the **spare parts** page at www.alvey.com.au
e: info@alvey.com.au
[#alveyreels](https://www.instagram.com/alveyreels)

Recommended Line Size

Your 62GRT4 model reel will hold approximately 300 metres of 5 kg line. If fishing near rocks or other hazards use heavier line to help avoid line breakage.

Filling the Spool with Line

Always take the line from the front of the dispenser, never the side.

Wind firmly and evenly onto the spool, spreading the line with your fingers to give a smooth casting base.

Never stretch a nylon monofilament onto a spool; when it goes back to its original length it will exert strong enough crushing action to damage your spool.

Never allow loose coils to develop on your spool through careless uneven winding.

Adopt the habit of applying light finger tension when retrieving line and spread evenly over its bed.

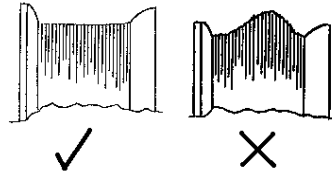

Selecting a Rod

Your rod and reel outfit should be balanced so you can hold it comfortably over long periods.

A matched set, which has a point of balance where it's held in the left hand, will give you the most comfortable posture. The ideal rod for this reel should be 3.2 to 3.6m in length.

The use of a short butt brings the reel into a natural position for rewinding with your elbows at your side and without strain.

Rigs & Swivels

When used properly a brass swivel is a very inexpensive and efficient way to keep a fishing line in good condition. Curls and twists in a line can be caused by many things, but can be kept to a minimum by the correct use of a swivel

Swivel Sizes	
Line breaking strain	Swivel size
1 – 5 kg	No 14
5 – 8 kg	No 12
8 – 15 kg	No 10
15 – 20 kg	No 9

Swivel must be above sinker

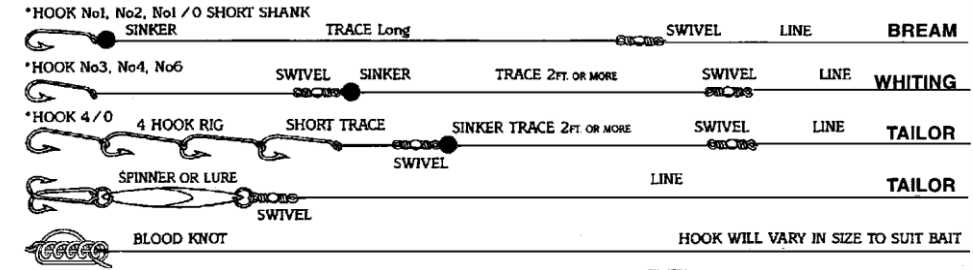

62GRT4



Rapid Retrieve Handle-plate

The outer handle provides maximum winding power at 1:1 ratio to turn and control large fish. The inner handle is designed to give up to a 35% increase in your retrieve rate, for running a lure or recovering your rig quickly if you loose the bait.

Playing the Fish

When you are ready to set the hook lift the rod with a smooth firm action and wind; if the fish runs and demands line release your grip on the handles and palm the spool by applying a gentle pressure on the bottom line surface of the spool.

Once the fish has been hooked always keep a bend in the rod by holding it at an angle to the fish. With the power of an Alvey reel you are in control. Do not rush the fish. Allow the fish to tire by keeping a steady pressure on the spool. Many times the fish is lost in the shore break. Keep a steady tension on your line, a bend in the rod and ease the fish ashore.

Maintenance

Use light machine oil on working spindles, handles and index mechanism. After each day of fishing wash off salt and sand and lubricate as above before storage.

The Simple method for LONG DISTANCE SURF CASTING With the world's best side-cast reel – ALVEY!

1. To begin, place fingers of left hand on spool lip and thumb on release lever. Press lever... turn spool

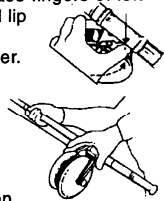

2. Turn spool a full quarter to open-face casting position.

3. Release line from open runner. Restrain line with thumb on spool.

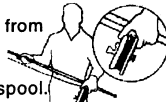

4. Casting position: Arms high rod held over shoulders, reel above rod.

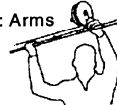

5. Casting action: Punch hard with right hand, pull downward with left hand.

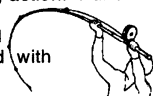

6. Casting drive: Follow through while releasing line grip as power is applied. Rod butt must clear left leg.

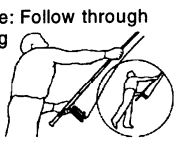

7. End of cast: Trap line at reel base. Turn drum back to fishing position.

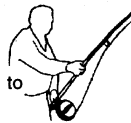

8. Return line to open runner.

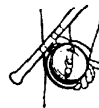

9 & 10 A comfortable fishing position makes hooking, playing or landing a fish more efficient.

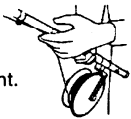

If you're left-handed simply carry out above instructions the other way round.